

A Higher Level of Performance



Data Sheet

Centurion Guided Radar

CGR Series



For more information, please visit >
www.hawkmeasure.com

Overview / Dimensions

Centurion Guided Radar



Principle of Operation

Guided-wave technology sends the radar pulse down a probe to measure liquids & liquid interface (low to high dielectric layers).

The pulse hits the surface of the first layer (low dielectric layer) and is reflected back up the probe. The pulse continues to the second interface (high dielectric layer) and is then reflected back to the probe. The transit time for both layers is translated into a distance using time of flight and time expansion.

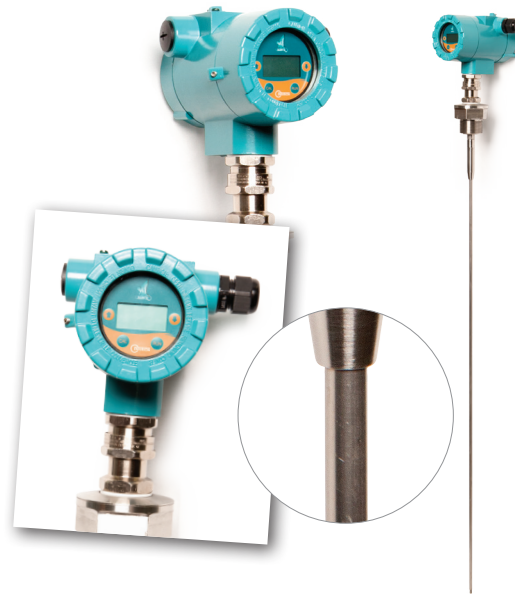

Function

The HAWK range of Guided Radar products are ideal for the measurement of liquids, sludge, powders and granules to a range of 18.5m for level and interface. This technology is not affected by pressure, temperature, viscosity, vacuum, foam, dust, changes in dielectric constant or coating of the probe.

Features

- Level & Interface level measurement
- Up to 18.5m (60ft 8in) range
- Very short minimum range (150mm, 6")
- Simple setup
- Auto-Calibration to any dielectric ≥ 1.5
- Adjustable Sensitivity

Primary Areas of Application

- Chemicals
- Petrochemicals
- Cement
- Building Aggregates
- Mining / Minerals
- Food & Beverages
- Oil & Gas
- Pharmaceutical
- Pulp & Paper
- Wastewater

- Precise & continuous accuracy
- 14-28VDC
- Modbus
- Protection class IP66, NEMA 4x
- Measures extremely low dielectric (1.5)
- Programmable fail safe mode

Wiring Terminal Compartment

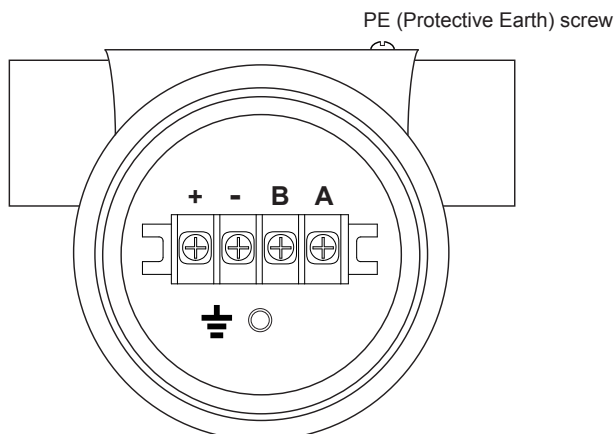

Dimensions - Reference

1	Housing
2	Barrier Gland / High Temp extension with Barrier Gland / End position with Barrier Gland
3	Threaded Connection / Flange
4	Probe Length

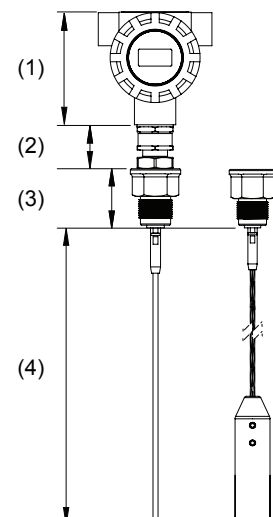



Dimensions Housing + Barrier Gland

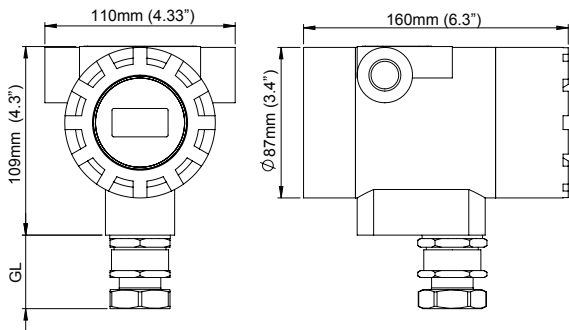

Barrier Gland Length (GL)			
Process Temp. Option*	Approval Option*	Length	
		mm	in
1	XX, 1D, 2D, 2A	55	2.2
3	XX, 1D, 2D, 2A	105	4.1
4, 5, 6	XX, 1D, 2D, 2A	145	5.7

Housing with Process Temperature option '2'.
Visual Reference only

Approval Option
XX

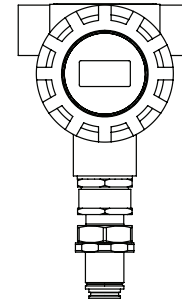

Dimensions - Probe Variants

A04 / A06 / A08 / J04 / J06 / J08

Threaded

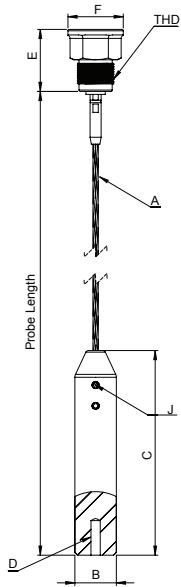

Welded Flange

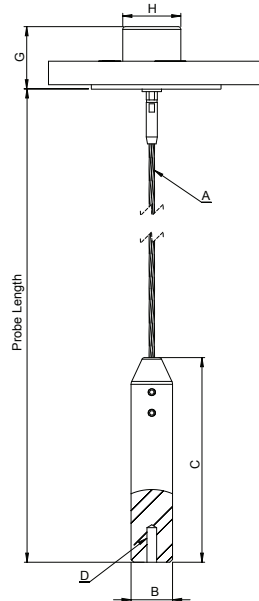

B04 / B06 / B08 / K04 / K06 / K08

Threaded

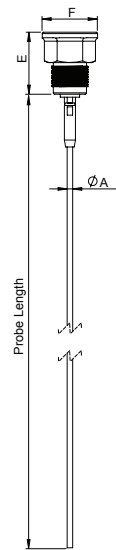

Welded Flange

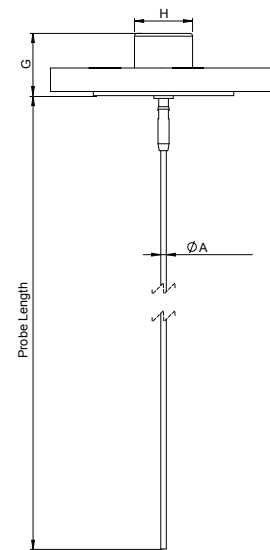

Probe / Cable Dimensions

Probe Type	THD BSP or NPT	A		B		C		E		F		D Internal Threads (A04, A06, A08 only)	J (Tightening Torque = 20Nm)	
		in.	mm	in.	mm	in.	mm	in.	mm	in.	mm		in.	Set Screw
A04, B04, J04, K04	3/4	4	0.16	22	0.9	120	4.7	45	1.8	40	1.6	M10x1.25, 24mm deep	3x M8x1.25x12	4mm
A06, B06, J04, K04	1	6	0.24	28	1.1	150	5.9	45	1.8	40	1.6	M10x1.25, 24mm deep	3x M8x1.25x12	4mm
A08, B08, J04, K04	1-1/2	8	0.31	36	1.4	200	7.8	72	2.8	64	2.5	M10x1.25, 24mm deep	3x M10x1.5x18	5mm
	Welded Flange	G		H										
		mm	in.	mm	in.									
A04, B04, J04, K04		45	1.8	42	1.6									
A08, B08, J04, K04		72	2.8	70	2.7									



Centurion Guided Radar System

3/4" & 1" Threaded Units (mounting option TN07, TB07, TN10, TB10)

Model

CGR2 2 wire Centurion Guided Radar

Communication

W Modbus with Interface Level Measurement

Housing

- 1 Aluminium, Epoxy Painted
- 2 316L Stainless Steel

Gland Entry

- 1 1/2" NPT Cable gland entry
- 2 3/4" NPT Cable gland entry
- 3 M20 x 1.5 Cable gland entry
- 4 M25 x 1.5 Cable gland entry

Probe Type

- A04 4mm flexible cable
- A06 6mm flexible cable
- B04 4mm rigid probe
- B06 6mm rigid probe
- J04 Detached 4mm flexible cable
- J06 Detached 6mm flexible cable
- K04 Detached 4mm rigid probe
- K06 Detached 6mm rigid probe

Probe variant / materials

- S 316L

Mounting

- TN07 3/4" NPT Thread (316L)
- TB07 3/4" BSP Thread (316L)
- TN10 1" NPT Thread (316L)
- TB10 1" BSP Thread (316L)
- FXXX¹ Pre-Welded Flange (replace XXX with 3 character Welded Flange Code)

Process O-ring seal / Process Temperature

V1	FKM (Viton)	(-40°C to +80°C)	(-40°F to +176°F)
V4	FKM (Viton)	(-40°C to +150°C)	(-40°F to +302°F)
B1	NBR	(-40°C to +80°C)	(-40°F to +176°F)
E1	EPDM	(-40°C to +80°C)	(-40°F to +176°F)
E3	EPDM	(-40°C to +130°C)	(-40°F to +266°F)
M1	FFKM (Markez)	(-10°C to +80°C)	(+14°F to +176°F)
M4	FFKM (Markez)	(-10°C to +150°C)	(+14°F to +302°F)
M5	FFKM (Markez)	(-10°C to +200°C)	(+14°F to +392°F)
M6	FFKM (Markez)	(-5°C to +250°C)	(+23°F to +482°F) (Max Process Pressure 40 bar)
S1	Silicone	(-40°C to +80°C)	(-40°F to +176°F)

Process Pressure

- 1 6 bar
- 3 20 bar
- 4 40 bar
- 5 100 bar

Approval Standard

XX Not Required

Probe Length

Specify in cm

CGR2 H 1 3 B04 S TN10 B1 1 XX 200

Probe / Mounting Combination Table

Probe Code	Variant / Materials	Mounting	Flange Sizes ²		Max. Length
			Min. Size	Max size	
A04 / J04	S	TN07, TB07, FXXX	1", DN25, 25mm	4", DN100, 100mm	1850cm
A06 / J06	S	TN10, TB10	2", DN50, 50mm	4", DN100, 100mm	1850cm
B04 / K04	S	TN07, TB07, FXXX	1", DN25, 25mm	4", DN100, 100mm	400cm
B06 / K06	S	TN10, TB10	2", DN50, 50mm	4", DN100, 100mm	400cm

¹See Weld Code selection in Flange Table.

²Hawk Supplied Flanges. End user can use any appropriate flange with suitable bore hole.



Centurion Guided Radar System

1.5" Threaded Units (mounting option TN15/TB15)

Model

CGR2 2 wire Centurion Guided Radar

Communication

W Modbus with Interface Level Measurement

Housing

- 1 Aluminium, Epoxy Painted
- 2 316L Stainless Steel

Gland Entry

- 1 1/2" NPT Cable gland entry
- 2 3/4" NPT Cable gland entry
- 3 M20 x 1.5 Cable gland entry
- 4 M25 x 1.5 Cable gland entry

Probe Type

- A08 8mm flexible cable
- B08 8mm rigid probe
- J08 Detached 8mm flexible cable
- K08 Detached 8mm rigid probe

Probe variant / materials

S 316L

Mounting

- TN15 1.5" NPT Thread (316L)
- TB15 1.5" BSP Thread (316L)
- FXXX¹ Pre-Welded Flange (replace XXX with 3 character Welded Flange Code)

Process O-ring seal / Process Temperature

- V1 FKM (Viton) (-40°C to +80°C) (-40°F to +176°F)
- V3 FKM (Viton) (-40°C to +130°C) (-40°F to +266°F)
- B1 NBR (-40°C to +80°C) (-40°F to +176°F)
- E1 EPDM (-40°C to +80°C) (-40°F to +176°F)
- E3 EPDM (-40°C to +130°C) (-40°F to +266°F) (Maximum Process Pressure 6 bar)
- S1 Silicone (-40°C to +80°C) (-40°F to +176°F)
- S3 Silicone (-40°C to +130°C) (-40°F to +266°F) (Maximum Process Pressure 6 bar)

Process Pressure

- 1 6 bar (87 psig)
- 3 20 bar (290 psig)
- 4 40 bar (580 psig)

Approval Standard

XX Not Required

Probe Length

Specify in cm

CGR2 H 1 3 B08 S TN15 B1 1 XX 200

Probe / Mounting Combination Table

Probe Code	Variant / Materials	Mounting	Flange Sizes		Max. Length
			Min. Size	Max size	
A08 / J08	S	TN15, TB15, FXXX	2", DN50, 50mm	4", DN100, 100mm	1850cm
B08 / K08	S	TN15, TB15, FXXX	2", DN50, 50mm	4", DN100, 100mm	400cm

¹See Weld Code selection in Flange Table.

²Hawk Supplied Flanges. End user can use any appropriate flange with suitable bore hole.



Mounting Flanges

Threaded Flanges

Model

FLA - Flange Size

- 1 1" or DN25 or 25mm
- H 1 1/2" or DN40 or 40mm
- 2 2" or DN50 or 50mm
- K 2 1/2" or DN65 or 65mm
- 3 3" or DN80 or 80mm
- L 3 1/2" (ANSI ONLY)
- 4 4" or DN100 or 100mm

Flange Type

- A1 ANSI B16.5 150LB FLANGE
- A3 ANSI B16.5 300LB FLANGE
- A6 ANSI B16.5 600LB FLANGE
- A9 ANSI B16.5 900LB FLANGE
- AA ANSI B16.5 1500LB FLANGE
- AB ANSI B16.5 2500LB FLANGE
- D6 DIN2527 PN6 FLANGE
- D0 DIN2527 PN10 FLANGE
- D1 DIN2527 PN16 FLANGE
- D2 DIN2527 PN25 FLANGE
- D4 DIN2527 PN40 FLANGE
- J5 JIS 5K FLANGE
- J0 JIS 10K FLANGE
- J1 JIS 16K FLANGE
- J2 JIS 20K FLANGE
- J4 JIS 40K FLANGE
- S1 AS 2129 Table D
- S2 AS 2129 Table E
- S3 AS 2129 Table F
- S4 AS 2129 Table H

Material

- SS SS316L

Thread Type

- TB07 3/4" BSP THDs
- TB10 1" BSP THDs
- TB15 1 1/2" BSP THDs
- TN07 3/4" NPT THDs
- TN10 1" NPT THDs
- TN15 1 1/2" NPT THDs

FLA - 2 A1 - SS - TB15

Welded Flanges

Model

F Flange Size

- 1 1" or DN25 or 25mm
- H 1 1/2" or DN40 or 40mm
- 2 2" or DN50 or 50mm
- K 2 1/2" or DN65 or 65mm
- 3 3" or DN80 or 80mm
- L 3 1/2" (ANSI ONLY)
- 4 4" or DN100 or 100mm

Flange Type

- A1 ANSI B16.5 150LB FLANGE
- A3 ANSI B16.5 300LB FLANGE
- A6 ANSI B16.5 600LB FLANGE
- A9 ANSI B16.5 900LB FLANGE
- AA ANSI B16.5 1500LB FLANGE
- AB ANSI B16.5 2500LB FLANGE
- D6 DIN2527 PN6 FLANGE
- D0 DIN2527 PN10 FLANGE
- D1 DIN2527 PN16 FLANGE
- D2 DIN2527 PN25 FLANGE
- D4 DIN2527 PN40 FLANGE
- J5 JIS 5K FLANGE
- J0 JIS 10K FLANGE
- J1 JIS 16K FLANGE
- J2 JIS 20K FLANGE
- J4 JIS 40K FLANGE
- S1 AS 2129 Table D
- S2 AS 2129 Table E
- S3 AS 2129 Table F
- S4 AS 2129 Table H

F 2 D4

Specifications

Centurion Guided Radar



Electronics

Power

- 24VDC (14 to 28VDC)

Power Consumption

- <500mW @ 24VDC

Communications

- Modbus
- GoshawkII via Modbus

Maximum Range

- Flexible cable probe: 18.5m (60ft 8in)
- Rigid probe: 4m (13ft 1in)

Minimum Range (Blanking)

- 150mm

Dielectric Range

- ≥ 1.5

Frequency

- 2.2 GHz

Resolution

- Analog: 1uA
- Display: 1.0mm

Accuracy¹

- +/- 3mm

Measurements per second

- 3

Response Time

- <1 second (application dependant)

Sum of non linearity, non repeatability, hysteresis

- Analog +/- 0.02%

Repeatability

- +/- 3mm

Memory

- Non-Volatile (No backup battery required)
- >10 years data retention

Operating Temperature (Electronics)

- -40°C to +80°C (-40°F to +176°F)

Display

- 4 line graphic display (128 x 64 pixels)

Language

- English

Configuration

- 4 button (up down, Cal, Run), GoshawkII via HART

Electromagnetic Compatibility



CAN ICES-3(A)/NMB-3(A)

This device complies with Part 15, Subpart B Class A of the FCC Rules. Operation is subject to the following two conditions: (1) This device may not cause harmful interference, and (2) this device must accept any interference received, including interference that may cause undesired operation.

Note: This equipment has been tested and found to comply with the limits for a Class A digital device, pursuant to part 15 of the FCC rules. These limits are designed to provide reasonable protection against harmful interference when the equipment is operated in a commercial environment. This equipment generates, uses and can radiate radio frequency energy and, if not installed and used in accordance with the instruction manual, may cause harmful interference to radio communications. Operation of this equipment in a residential area is likely to cause harmful interference in which case the user will be required to correct the interference at his own expense.

*Specifications model dependent. Consult part number listing.

¹Accuracy dielectric & material dependent

**Process O-ring seal / Process Temperature dependent

Specifications

Centurion Guided Radar



Enclosure

Type

- Dual Compartment with Glass window

Material

- Die-cast Copper-Free Aluminium, Epoxy Painted
- 316L Stainless

Cable Entries

- 1/2" NPT
- 3/4" NPT
- M20 x 1.5
- M25 x 1.5

IP Rating

- NEMA 4X
- IP66

Probe

Probe Size

- 4mm SS316L rod
- 4mm DIN3055 (7x7 strand) SS316L flexible cable
- 6mm SS316L rod
- 6mm DIN3055 (7x7 strand) SS316L flexible cable
- 8mm SS316L rod
- 8mm DIN3055 (7x7 strand) SS316L flexible cable

Wetted Materials²

- TN07 / TB07 / TN10 / TB10 / Welded Flange¹ SS316L, PEEK
- TN15 / TB15 / Welded Flange¹ - SS316L, PTFE, GF25

¹ See Probe / Mounting Combination Table for flange types

Probe O-Ring Seals / Process Temperature*

- | | | |
|-----------------|-----------------|-------------------|
| • FKM (Viton) | -40°C to +150°C | (-40°F to +302°F) |
| • EPDM | -40°C to +130°C | (-40°F to +266°F) |
| • FFKM (Markez) | -10°C to +200°C | (+14°F to +392°F) |
| • FFKM (Markez) | -5°C to +250°C | (+23°F to +482°F) |
| • Silicone | -40°C to +80°C | (-40°F to +176°F) |
| • Silicone | -40°C to +130°C | (-40°F to +266°F) |
| • NBR | -40°C to +80°C | (-40°F to +176°F) |

Process Connections

- 3/4" NPT
- 1" NPT
- 1.5" NPT
- 3/4" BSP
- 1" BSP
- 1.5" BSP
- Threaded Flange
- Welded Flange

Process Pressure*

- -1 to 100 BAR

Tensile Load (flexible cable probes)

- | | |
|-------------------------|---------|
| • Probe Type: A04 / J04 | 0.5 ton |
| • Probe Type: A06 / J06 | 1.0 ton |
| • Probe Type: A08 / J08 | 4.0 ton |

Lateral Load (rigid probes)

- | | |
|-------------------------|------|
| • Probe Type: B04 / K04 | 1 Nm |
| • Probe Type: B06 / K06 | 3 Nm |
| • Probe Type: B08 / K08 | 8 Nm |

Probe Length

Max

Min

- | | | |
|-------------------------|--------|-------|
| • Probe Type: A04 / J04 | 1850cm | 100cm |
| • Probe Type: A06 / J06 | 1850cm | 100cm |
| • Probe Type: A08 / J08 | 1850cm | 100cm |
| • Probe Type: B04 / K04 | 400cm | 20cm |
| • Probe Type: B06 / K06 | 400cm | 20cm |
| • Probe Type: B08 / K08 | 400cm | 20cm |

*Specifications model dependent. Consult part number listing.

² PEEK or PTFE/GF25 probe entry

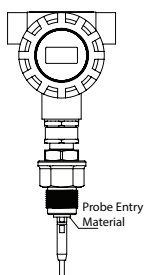

Ordering & Contact Information

Centurion Guided Radar



Ordering Instructions

Threaded unit type

Assemble part number taking note of the valid combinations and exclusions for the full system. The unit is ordered as a single line item. For example:

CGR4W13B08STB15B11XX200

Flanged type - Threaded flange

Assemble part number taking note of the valid combinations and exclusions for the full system. The unit and the threaded flange are ordered as separate line items.

For example:

CGR4W13B08STN15B11XX200

FLA-FA4-SS-TN15

or

CGR4W13B08STN07B11XX200

FLA-FA1-SS-TN07

Flanged type - Welded flange

Assemble part number taking note of the valid combinations and exclusions for the full system. In the Mounting part code enter 4 character Welded flange code from the table. All Welded flanges have F as the first character. For example.

CGR4W13B08SF4A1B11XX200

Hawk Measurement Systems (Head Office)

15 - 17 Maurice Court
Nunawading VIC 3131, AUSTRALIA

Phone: +61 3 9873 4750

Fax: +61 3 9873 4538

info@hawk.com.au

For more information and global representatives: www.hawkmeasure.com

Technical data subject to change without notice.

Hawk Measurement

90 Glenn Street
Suite 100B, Lawrence, MA 01843, USA

Phone: +1 888 HAWKLEVEL (1-888-429-5538)

Phone: +1 978 304 3000

Fax: +1 978 304 1462

info@hawkmeasure.com

Represented by:

